

Elements of BH Astrophysics

in the

Era of New Instruments

Vladimír Karas (Astronomical Institute, Prague)

`vladimir.karas@cuni.cz`

Some historical remarks

John Michell (1784): *Phil. Trans. Roy. Soc. Lond.*, LXXIV, 35

If there should really exist in nature any bodies whose density is not less than that of the sun, and whose diameters are more than 500 times the diameter of the sun, since their light could not arrive at us . . . we could have no information from sight; yet if any other luminous bodies should happen to revolve about them we might still perhaps from the motions of these revolving bodies infer the existence of the central ones. . . .

Pierre S. Laplace (1796): “*Exposition du Système du Monde*”

. . . the attractive force of a heavenly body could be so large that light could not flow out of it.

Some historical remarks

SCIENCE NEWS LETTER *for January 18, 1964*

ASTRONOMY

"Black Holes" in Space

The heavy densely packed dying stars that speckle space may help determine how matter behaves when enclosed in its own gravitational field—By Ann Ewing

But ...

... It is virtually impossible to prove unambiguously the presence of black-hole horizon by observing the electromagnetic signal from its presumed vicinity in a cosmic system – absence of radiation signal does not necessarily prove the absence of the surface of the body and the existence of the horizon.

(See Abramowicz et al. 2002, A&A, 396, L31)

Astrophysical BHs in GR

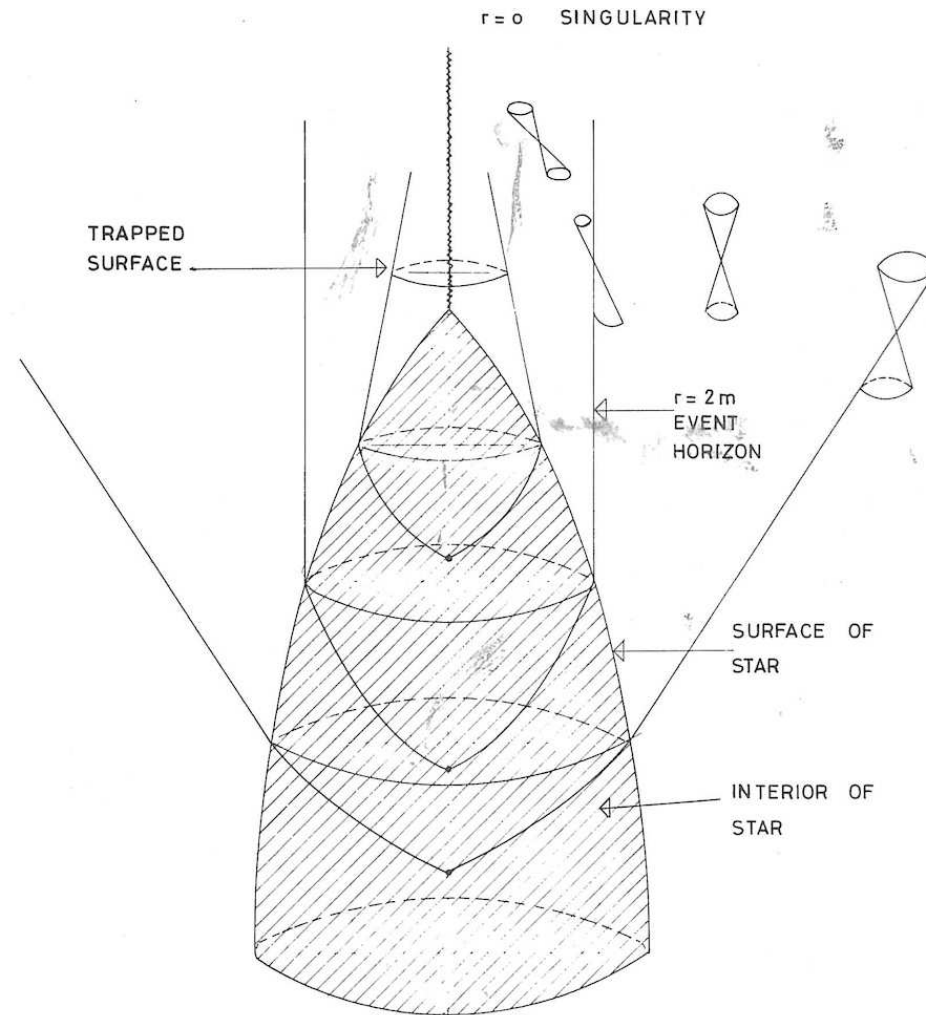

Emergence of Event Horizon and Trapped Surfaces.

(Hawking, 1972)

Objects and ideas

- Nuclei of galaxies: in AGN (quasars, Seyfert galaxies, ...)
- Stellar remnants: accreting BH and NS (microquasars, ...)

Objects and ideas

- Nuclei of galaxies: in AGN (quasars, Seyfert galaxies, ...)
- Stellar remnants: accreting BH and NS (microquasars, ...)
- Compact body (rotating Kerr BH, or an alternative?)
- Accretion disc (geometrically thin vs. a torus?)
 - + magnetic fields (jets), + self-gravity, ...
 - time-dependence, non-axisymmetry, polarimetry, ...

Objects and ideas

- Nuclei of galaxies: in AGN (quasars, Seyfert galaxies, ...)
- Stellar remnants: accreting BH and NS (microquasars, ...)
- Compact body (rotating Kerr BH, or an alternative?)
- Accretion disc (geometrically thin vs. a torus?)
 - + magnetic fields (jets), + self-gravity, ...
 - time-dependence, non-axisymmetry, polarimetry, ...
- model predictions vs. observations:
elmg. lightcurves & spectra (continuum, lines),
high-energy particles (TeV), gw synergy (TDEs)

Objects and ideas

- Nuclei of galaxies: in AGN (quasars, Seyfert galaxies, ...)
- Stellar remnants: accreting BH and NS (microquasars, ...)
- Compact body (rotating Kerr BH, or an alternative?)
- Accretion disc (geometrically thin vs. a torus?)
 - + magnetic fields (jets), + self-gravity, ...
 - time-dependence, non-axisymmetry, polarimetry, ...
- model predictions vs. observations:
elmg. lightcurves & spectra (power-spectra, SSC continua, broad lines), high-energy particles (TeV)
- GR effects taken into account: acceleration to relativistic speed • strong gravity lensing, energy shifts • variability time-scales → orbiting near ISCO • gw–elmg. synergy (TDEs)...

Characteristic scales

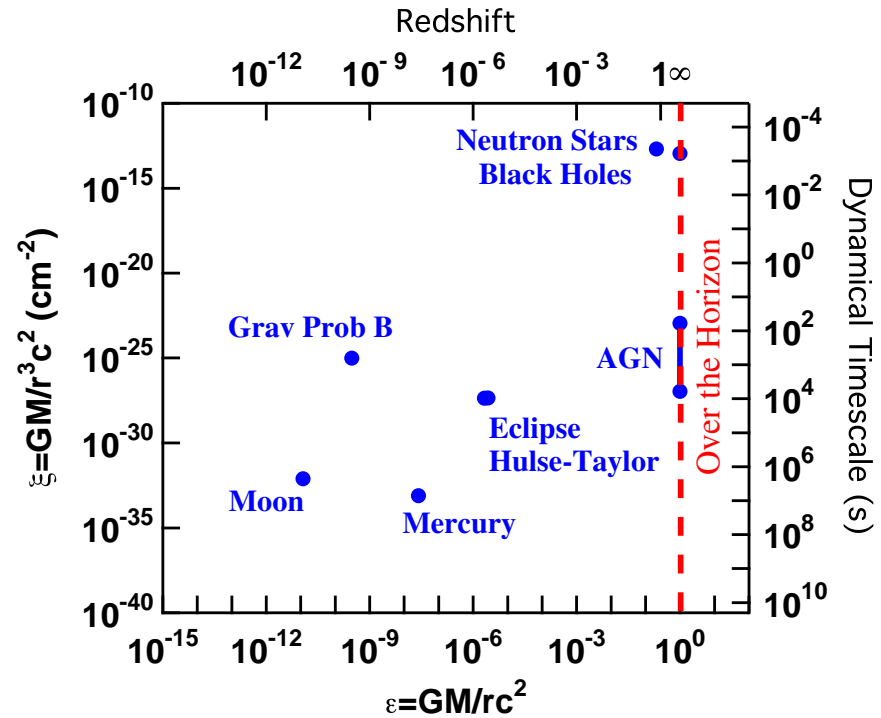
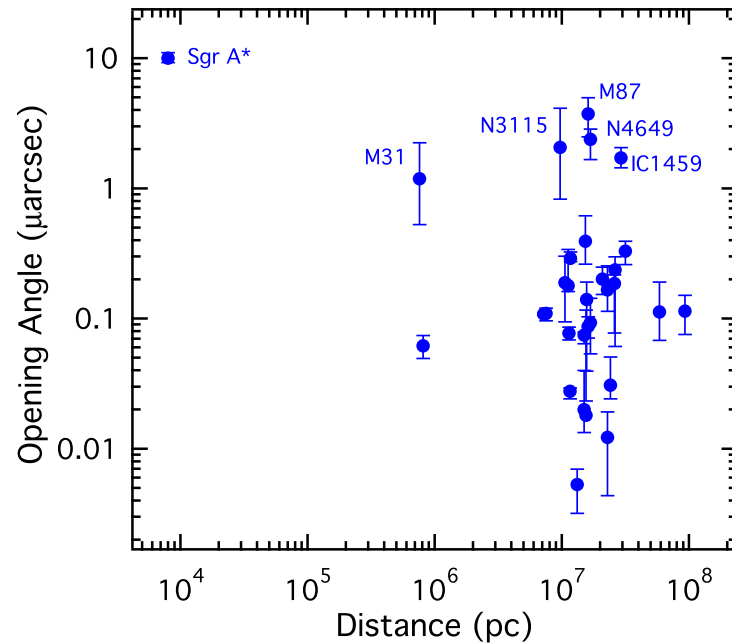

Characteristic scales and parameters of nearby SMBHs.

(Psaltis, LRR, 2008)

Accretion very close to BH

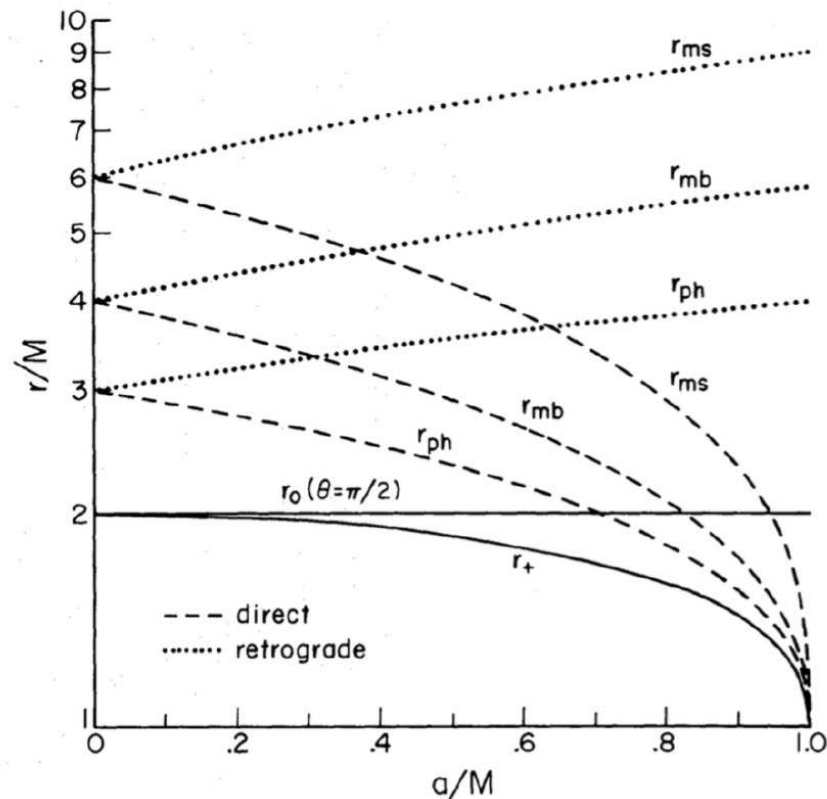
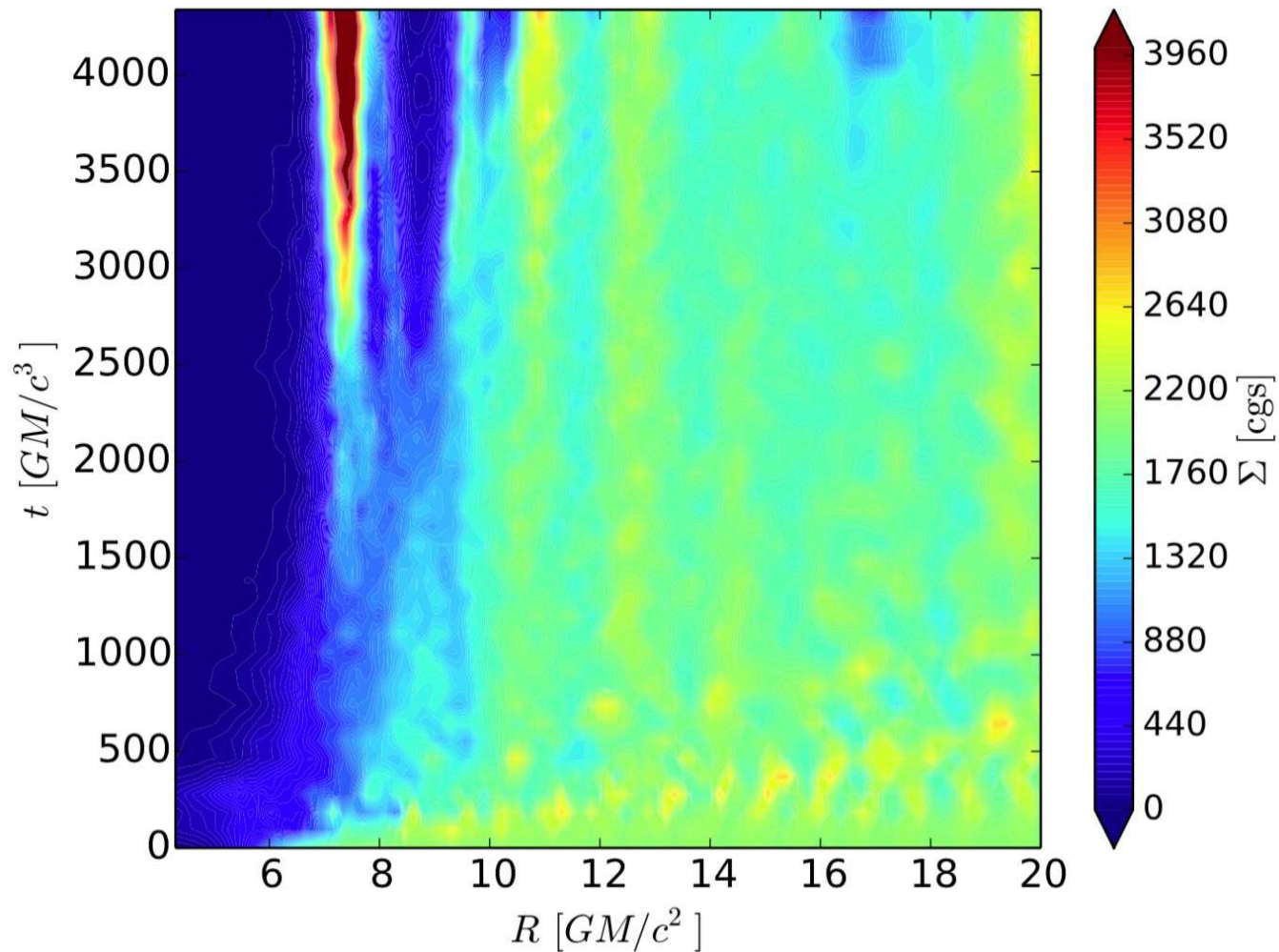

FIG. 1.—Radii of circular, equatorial orbits around a rotating black hole of mass M , as functions of the hole's specific angular momentum a . Dashed and dotted curves (for direct and retrograde orbits) plot the Boyer-Lindquist coordinate radius of the innermost stable (ms), innermost bound (mb), and photon (ph) orbits. Solid curves indicate the event horizon (r_+) and the equatorial boundary of the ergosphere (r_0).

Equatorial orbits of particles near a rotating BH ($|a/M| \leq 1$).

(Bardeen et al, ApJ, 1972)

3D GRMHD



Three-dimensional, global, radiative GRMHD simulations
of a thermally unstable disc.

(B. Mishra et al, MNRAS, 2016)

BH shadow and light circle

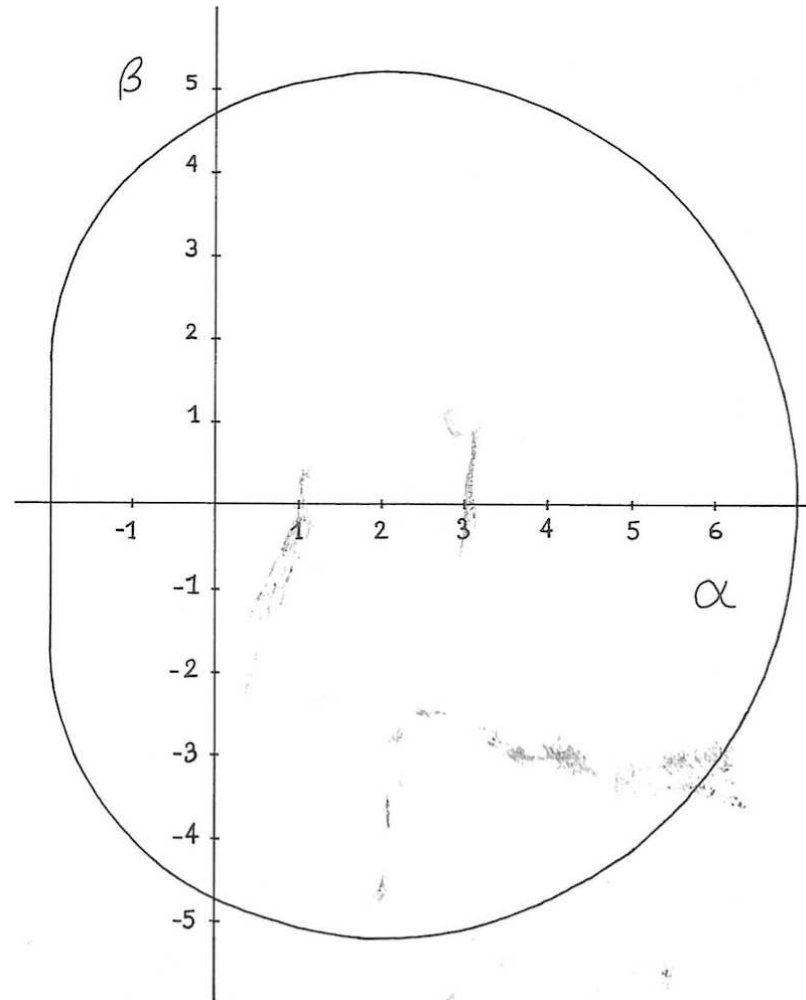

Apparent shape of an illuminated extreme Kerr BH.

(Bardeen, 1972)

Reverberation from TDEs

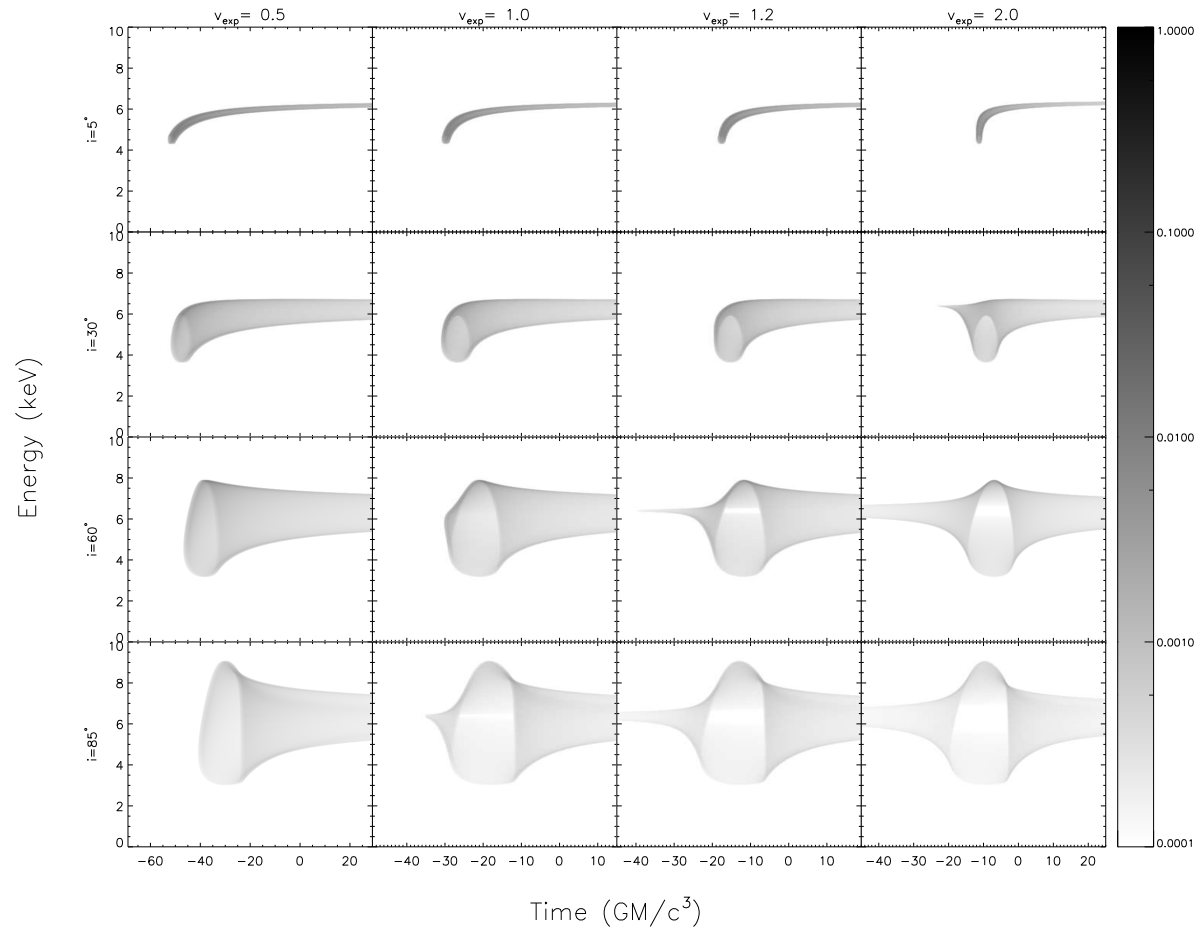

Zhang et al (2015), ApJ

Prospects for future: reverberation signatures
on remnants from tidal disruptions.

(Karas et al, Proc. RAGtime 2014; Kara et al, Nature 2016)

Reconnection in ergosphere?

(b)

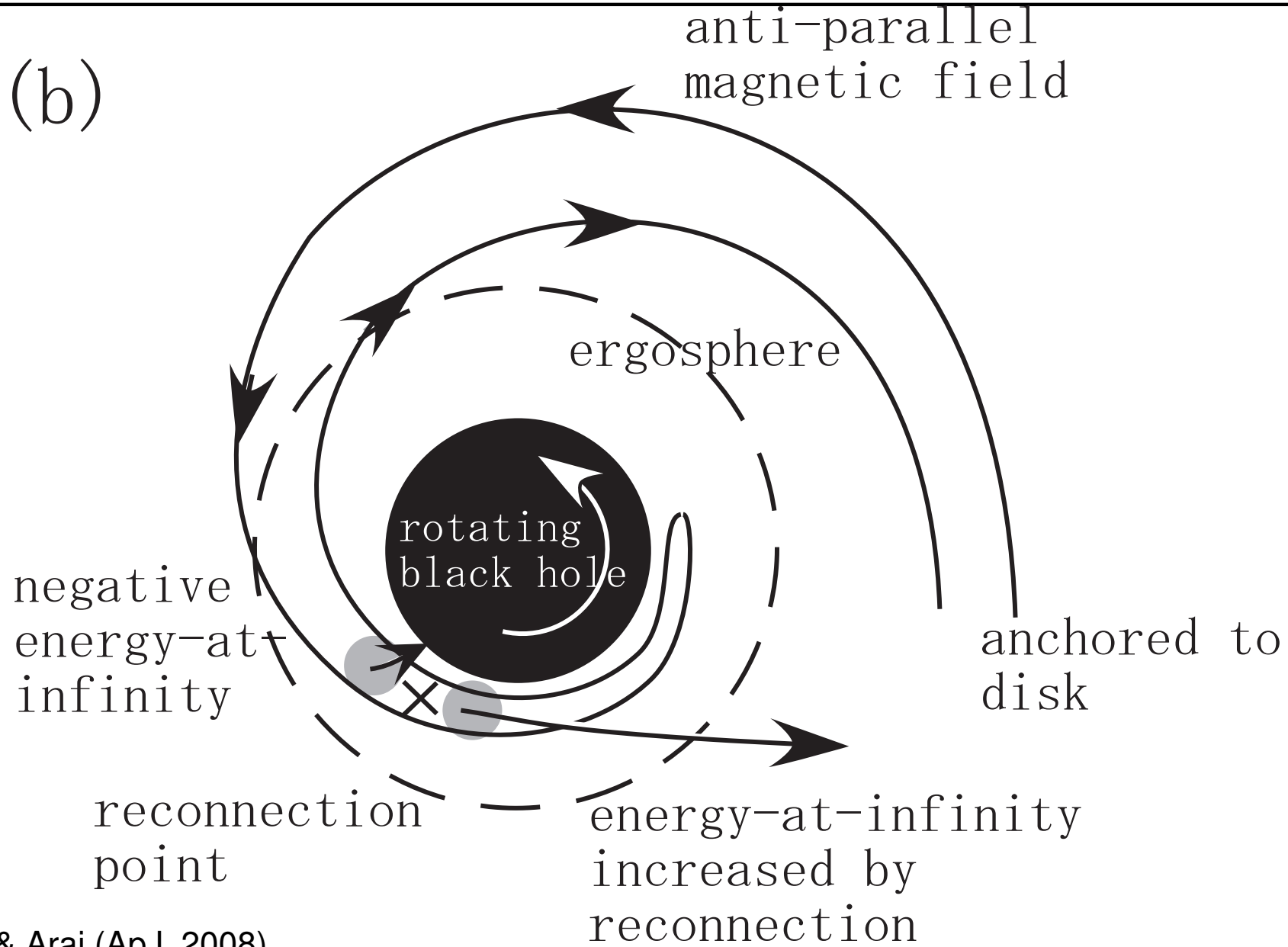

Koide & Arai (ApJ, 2008)

Reconnection in ergosphere?

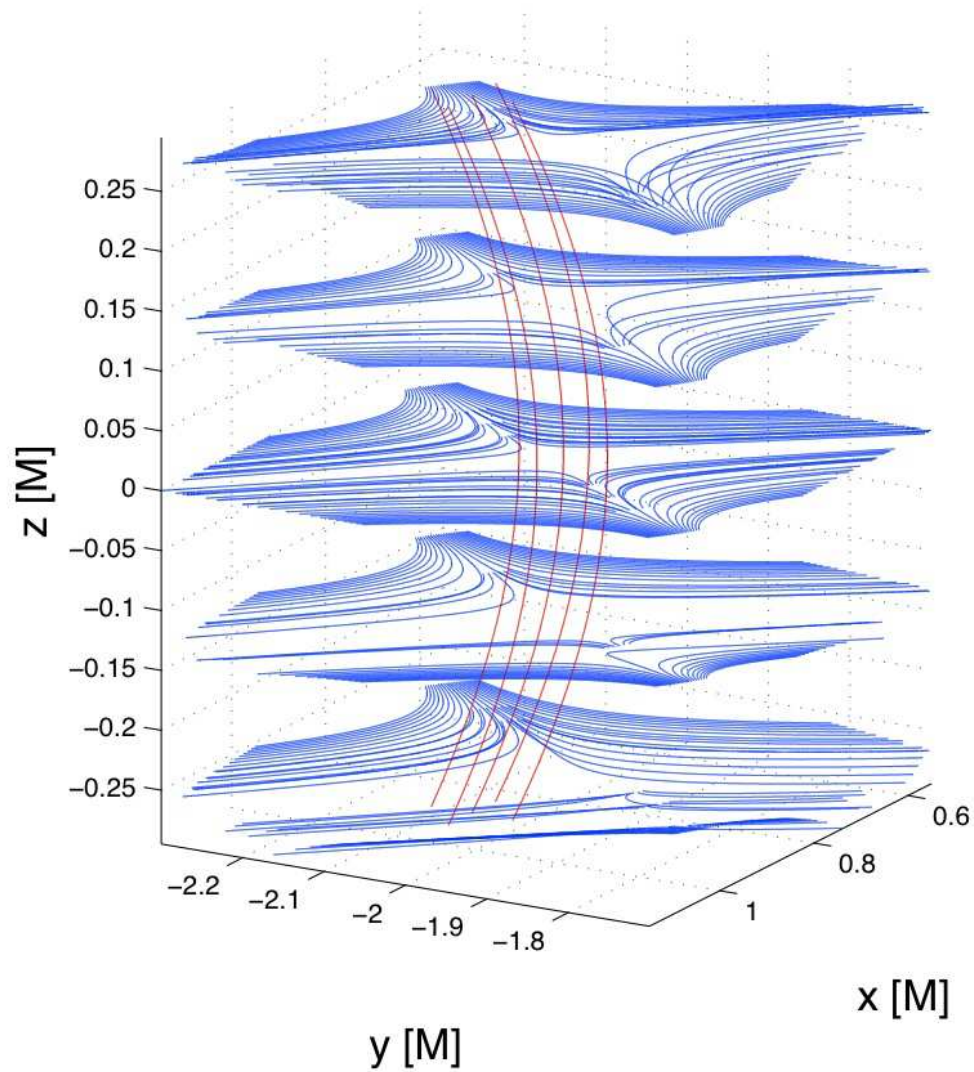

Karas, Kopáček & Kunneriath (CQG, 2012)

Binary BHs

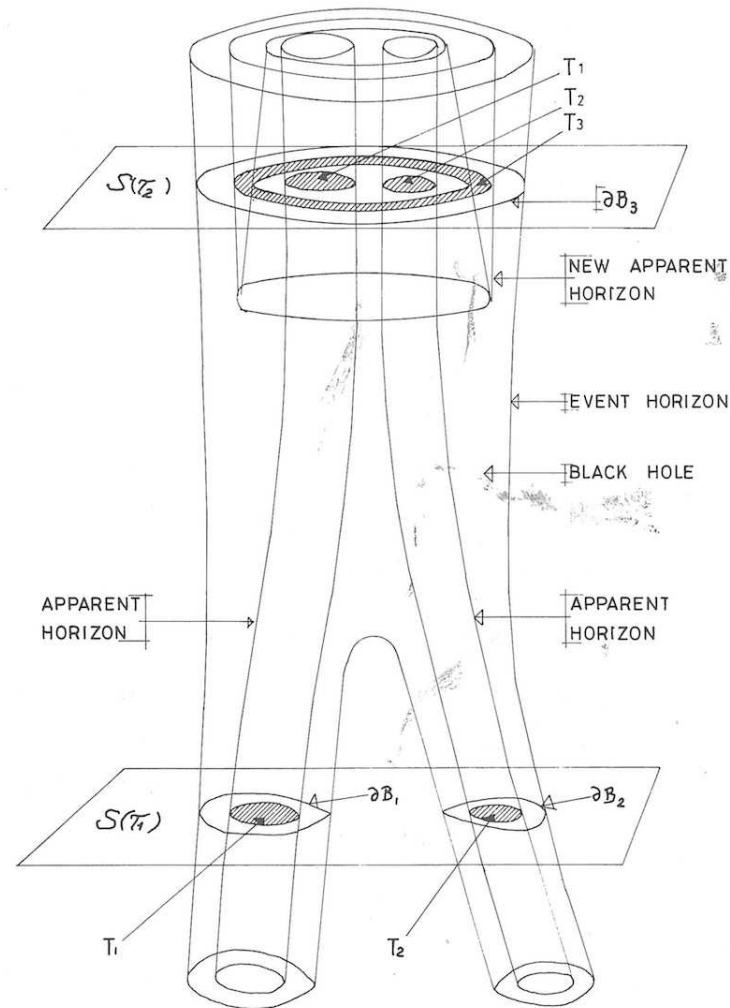

(Hawking, 1972)

Growth of horizon by BH mergers. Ratio of TDEs/gas accretion.
See further lectures at this meeting!

Thank you!